

#### 4. Safety

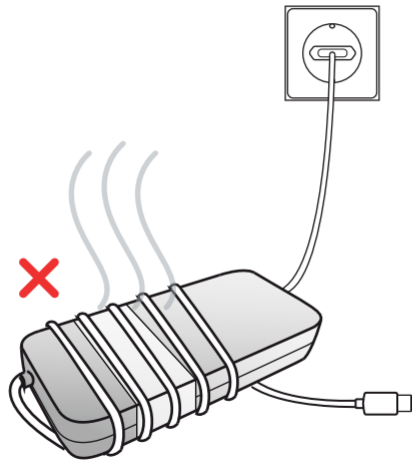

#### 5. Safety

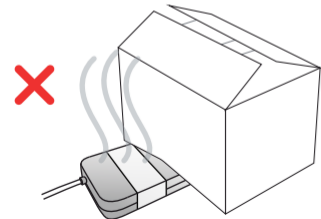
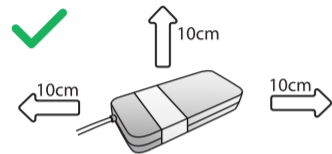
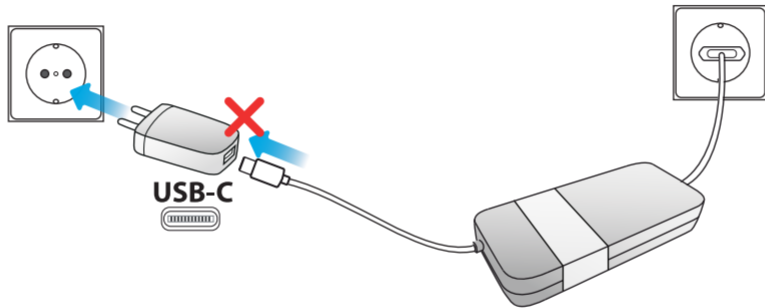

#### FAQ

Frequently Asked Questions  
[www.trust.com/21478/faq](http://www.trust.com/21478/faq)

**Trust**

**60W UNIVERSAL**  
USB-C charger

Quick Installation Guide



## 1. Charger

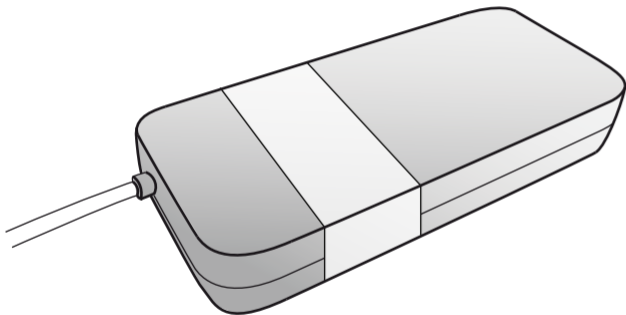

### Power

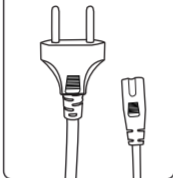

### USB

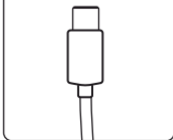

## 2. Setup

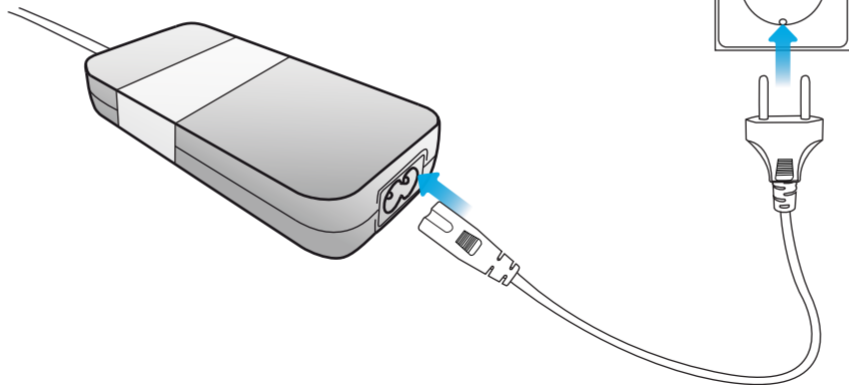

## 3. Charge Devices

