

Trust

735S POWERCAM ZOOM



User's manual

U K

D E

F R

I T

E S

P L

N L

P T

LIFE IS MORE! TRUST US

TRUST.COM

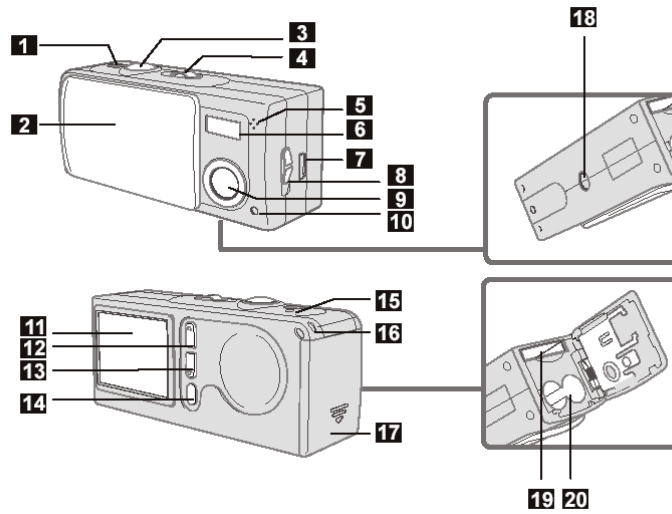

Figure 1

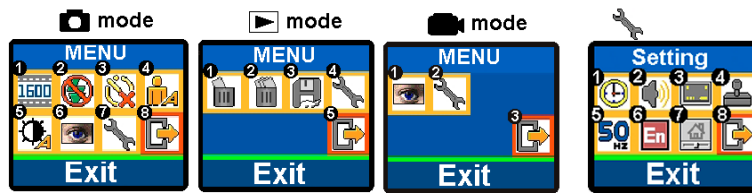

Figure 2



735S POWERC@M ZOOM

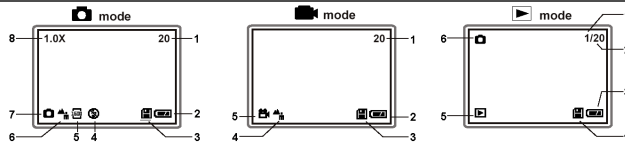

Figure 3

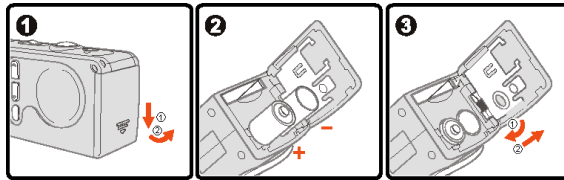

Figure 4

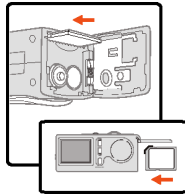

Figure 5

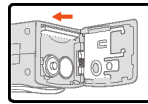

Figure 6

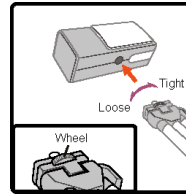

Figure 7

U K

D E

F R

I T

E S

P L

N L

P T

LIFE IS MORE! TRUST US

TRUST.COM

Trust

735S POWERCAM ZOOM



Figure 8



Figure 9



Figure 10

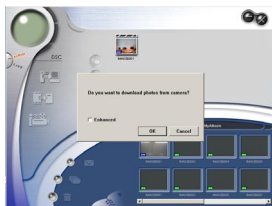

Figure 11



Figure 12



Figure 13

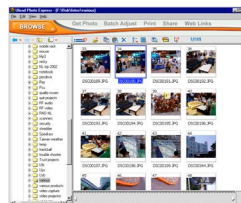

Figure 14

LIFE IS MORE! TRUST US

TRUST.COM

Trust

735S POWERC@M ZOOM

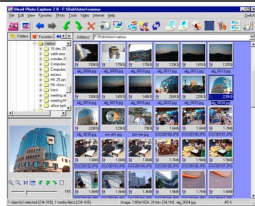

Figure 15

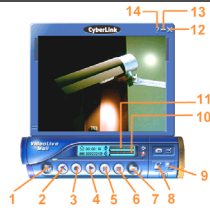

Figure 16

U K

D E

F R

I T

E S

P L

N L

P T

LIFE IS MORE! TRUST US

TRUST.COM



735S POWERC@M ZOOM

Thank you for your purchase. Register your product via our Internet site at www.trust.com/register, so that you will be eligible for optimal guarantee and service support. You will also be automatically informed of the development of your and other Trust products.

Vielen Dank, dass Sie unser Produkt gekauft haben. Registrieren Sie jetzt ihr Produkt auf unserer Website, www.trust.com/register, so dass Sie unsere optimale Garantie- und Serviceunterstützung in Anspruch nehmen können. Außerdem werden Sie automatisch über die Entwicklung Ihres und anderer Produkte auf dem Laufenden gehalten.

Nous vous remercions de votre achat. Enregistrez-le maintenant sur notre site Internet, www.trust.com/register, et vous aurez droit à une garantie et un soutien de service optimaux. En outre, vous serez informé automatiquement des mises à jour de votre produit et des autres produits de Trust.

Grazie per aver acquistato un prodotto Trust. Registra l'acquisto effettuato presso il sito internet Trust (www.trust.com/register), in questo modo potrà usufruire dell'assistenza e della garanzia. Inoltre potrà ottenere informazioni aggiornate sulle novità riguardanti il suo prodotto ed anche gli altri prodotti Trust.

Muchas gracias por su adquisición. Registre ahora su adquisición a través de nuestro sitio en Internet, www.trust.com/register, de modo que tenga derecho al soporte de garantía y de servicio óptimo. Se mantendrá, además, automáticamente al corriente de los desarrollos de su producto y de los demás productos de Trust.

Serdecznie dziękujemy za zakup naszego produktu. Rejestrując już teraz swój zakup na stronie internetowej firmy Trust, www.trust.com/register, uzyskacie Państwo optymalne wsparcie gwarancyjne i serwisowe. Ponadto będziecie Państwo automatycznie informowani o wszelkich zmianach odnośnie tego i innych produktów firmy Trust.

Hartelijk dank voor uw aankoop. Registreer nu uw aankoop via onze internet site, www.trust.com/register, zodat u in aanmerking komt voor optimale garantie- en service ondersteuning. Bovendien wordt u automatisch op de hoogte gehouden van de ontwikkeling van uw en andere Trust producten.

Obrigado pela sua aquisição. Registe a sua compra no nosso sítio Internet, www.trust.com/register, a fim de poder usufruir dos nossos óptimos serviços de garantia e assistência. Ao registar será automaticamente informado sobre novos desenvolvimentos no seu e em outros produtos da Trust.

U K

D E

F R

I T

E S

P L

N L

P T

Version 1.0

LIFE IS MORE! TRUST US TRUST.COM



CUSTOMER CARE CENTERS

24 HOURS free service: www.trust.com		
Residents in the UK and Ireland should contact:		
Mon - Fri From 8:00 - 16:00	UK Office Phone Fax	+44-(0)845-6090036 +31-(0)78-6543299
I residenti in Italia possono contattare:		
lun - ven 9:00 - 13:00 / 14:00 -18:00	Ufficio italiano Telefono Fax	+39-051-6635947 +39-051-6635843
Les habitants de la France et de l'Afrique du Nord peuvent contacter :		
Lundi-vendredi De 9:00 à 17:00	Bureau français Téléphone Fax	+33-(0)825-083080 +31-(0)78-6543299
Kontaktadresse für Einwohner Deutschlands:		
Mo - Fr 9:00 - 17:00	Deutsche Geschäftsstelle Telefon Fax	0800-00TRUST (0800-0087878) +31-(0)78-6543299
Los habitantes de España pueden ponerse en contacto con:		
lun - viernes De las 9:00 a las 17:00 horas	Oficina española Teléfono Fax	+34-(0)902-160937 +31-(0)78-6543299
Osoby mieszkające na terytorium Polski powinny skontaktować się:		
Od pon. do pt. w godz 09:00-17:00	Biuro w Polska Tel Fax	+48-(0)22-8739812 +31-(0)78-6543299
Inwoners van Nederland kunnen contact opnemen met:		
ma - vr 9:00 - 17:00 uur	Kantoor Nederland Telefoon Fax	0800-BELTRUST (0800-23587878) +31-(0)78-6543299
All other countries / Alle anderen Länder / Tous les autres pays Tutti gli altri paesi / Todos los demás países / Alle andere landen		
Mon - Fri From 9:00 - 17:00	European Head Office Phone Fax	+31-(0)78-6549999 +31-(0)78-6543299

LIFE IS MORE! TRUST US

TRUST.COM